

# Data Sheet

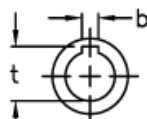

Article number: 2301077221  
Description: E+G Handwheel  
VR.125 FP+I

## Measures

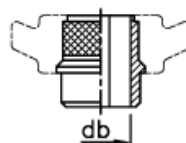
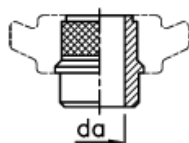
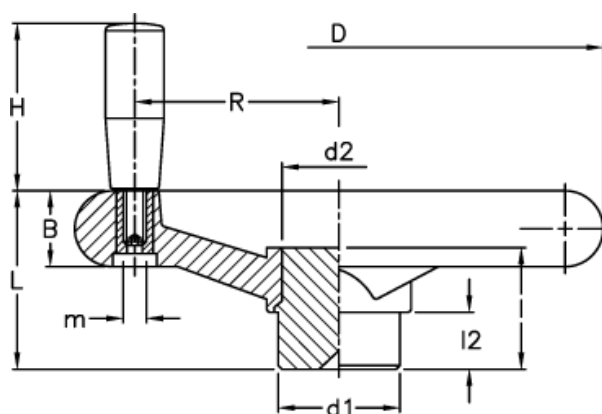

da max tilladelig boring uden not

db max tilladelig boring med not

b	= 5	H	= 50
B	= 18	l	= 36
C (N m)	= 120	L	= 45
D	= 124	L (J)	= 8
d1	= 24	l2	= 12
d2	= 20	m	= M8
da	= 16	R	= 47
db	= 13	t	= 15.3